

BG-GW430

3KW

V1.0



1)

2)

3)



1

2

3

4	-	25
4.1		25
4.2		28
4.2.1	 !	
4.3		30
4.3.1		30
4.3.2		30
4.3.3		31
4.3.4	 !	
5		34
5.1		35
5.2		35
5.3		36
5.3.1		36
5.4		37
5.4.1		37
5.4.2		38
5.5	2 432Am4

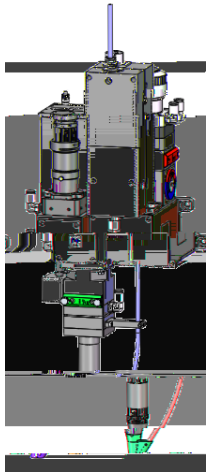
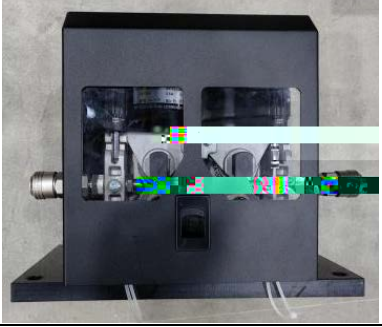
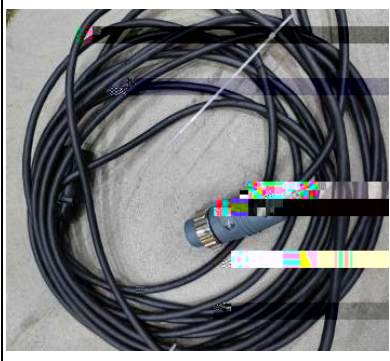

1.2

	BG.GW430.0001	1	
	CK.JQR00.0049	1	
10m)	XQ.WIR08.0187	1	

10m)	XQ.WIR08.0187	1	
15 m)	XQ.WIR09.0193	1	
	YM.BJZ05.0018	1	
3m	XM.SSP00.0071	1	

1.5m

XM.SSP00.0072 1

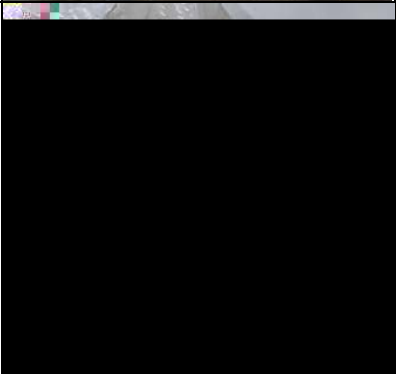
<p>0.8mm 1.0mm 1.2mm 1.6mm</p>	<p>XP.JSJ04.0784 XP.JSJ04.0777 XP.JSJ04.0776 XP.JSJ04.0775</p>	
<p>(0.8mm&1.0mm&1.2mm&1.6mm)</p>	<p>XM.SSP00.0058 XM.SSP00.0061</p>	
<p>(0.8mm&1.0mm&1.2mm&1.6mm)</p>	<p>XM.SSP00.0060 XM.SSP00.0064 XM.SSP00.0062 XM.SSP00.0065</p>	

2.3

2.3.1

BG.GW430.0001

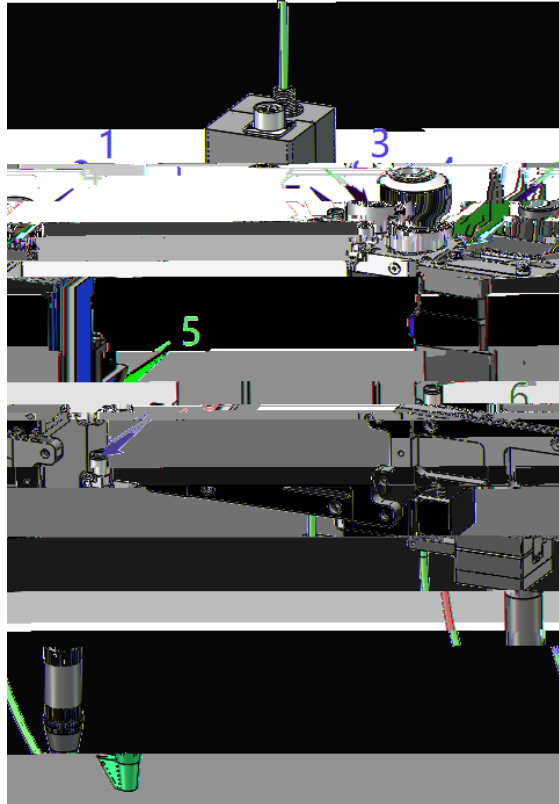

1. 6mm 2-3-4-5 ()

2. 1

3. 6

	1.8 /
	0.48gpm

	0.4Mpa
	(25)/
CaCO3	250mg
PH	6-8(
	200

2.3.2

BG.GW430.0001

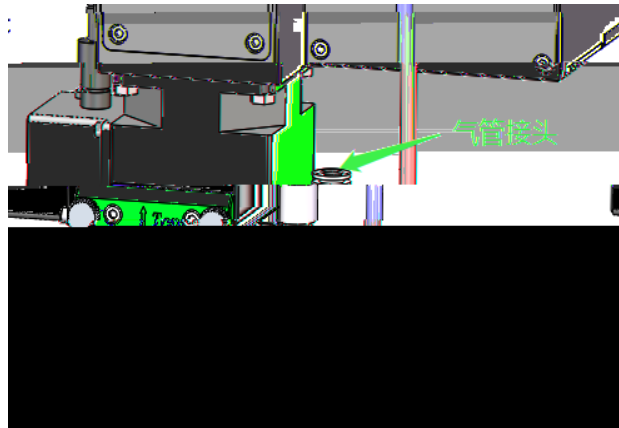

6mm



		ppm	(ppm)
--	--	-----	-------

	99.95%	5 ppm	1 ppm
	99.995%	5 ppm	1 ppm
	99.998%	5 ppm	1 ppm
	99.998%	5 ppm	1 ppm

2.4

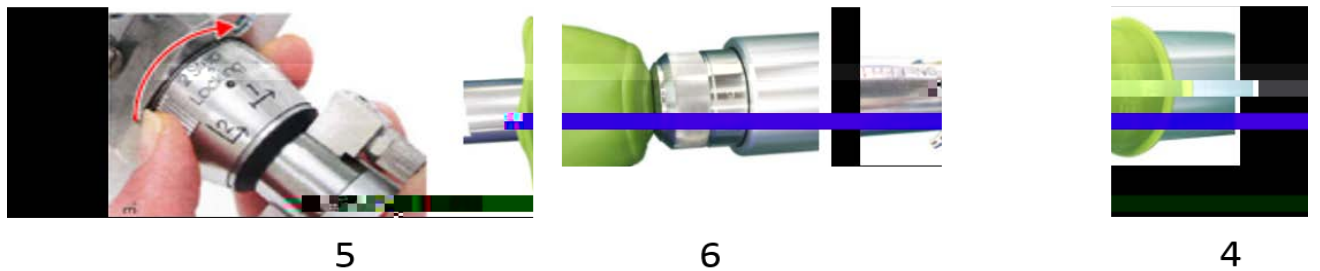
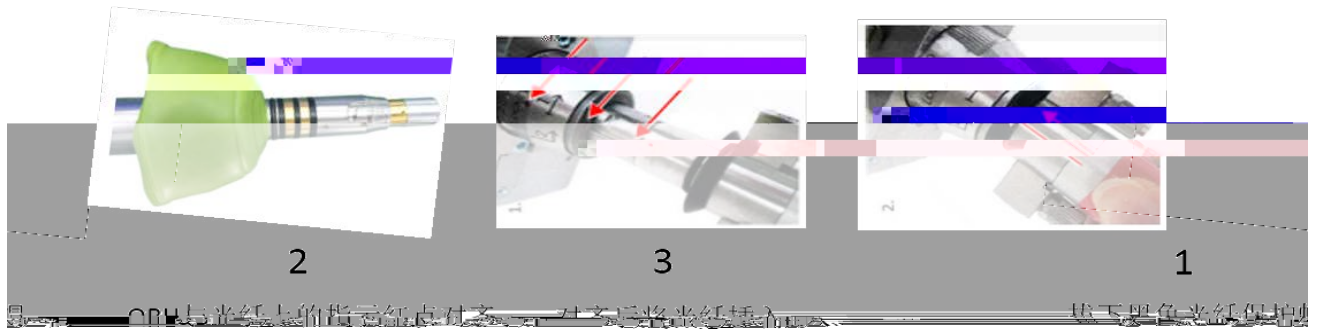

OBH旋帽完成

将旋帽往外拔。

光纤安装完成

到位后再沿标记方向旋转完成二级锁紧。

沿标记方向旋转O
一级锁紧。

完成一级锁紧后

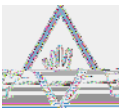

螺杆

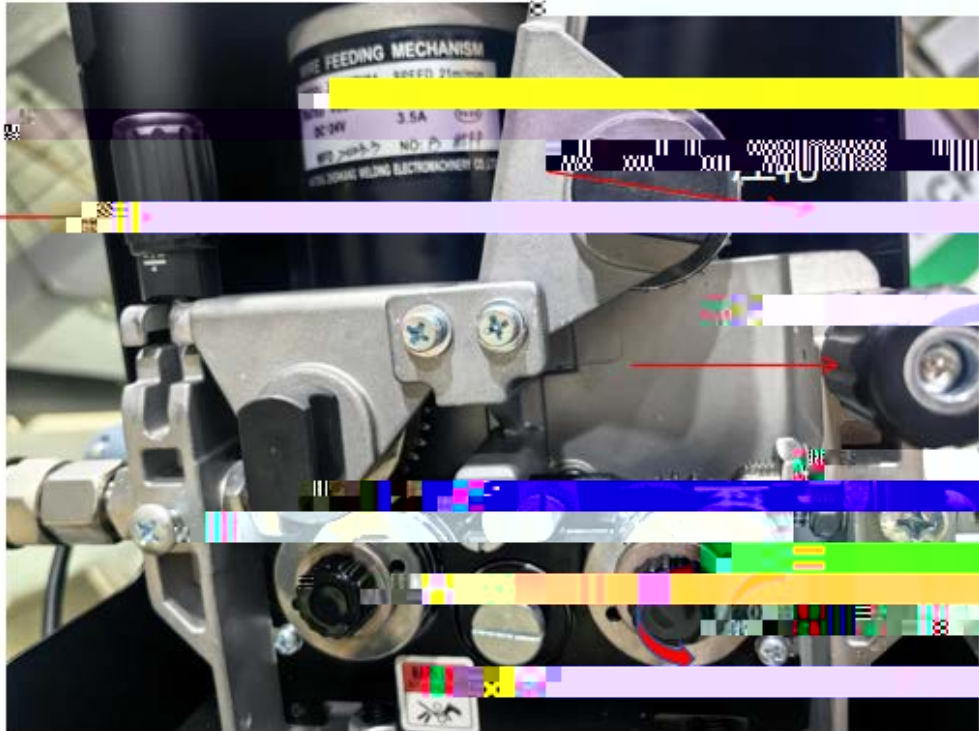

- 1.
- 2.
- 3.

4.

5.

6.

7.

8.

2.6.3

” ”

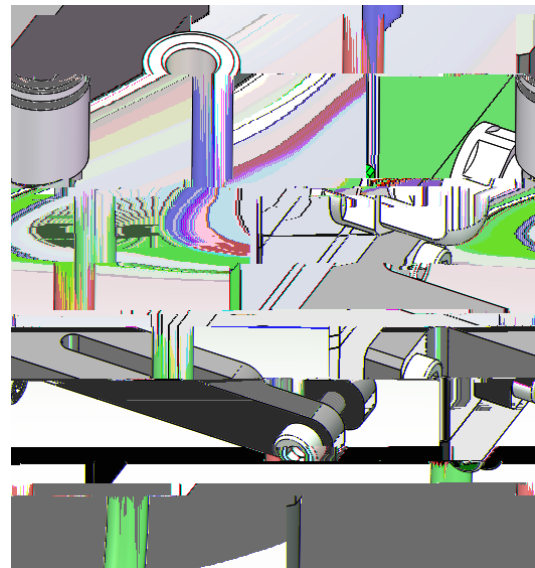
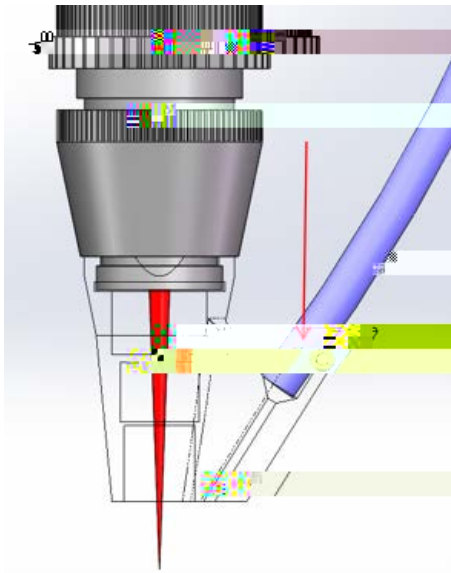

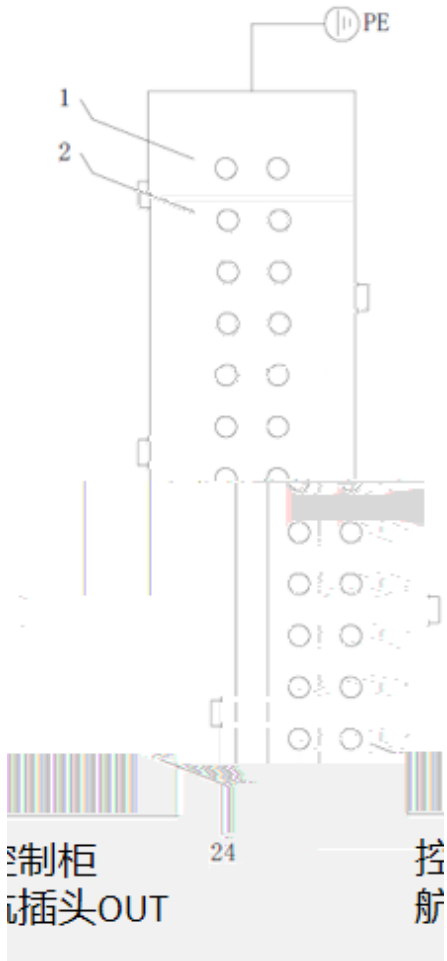

线号	线标	定义	线号	线标	定义
1	DA+	模拟量输出+	13		
2	DA-	模拟量输出-	14		
			16	Error	报警输出
			17		

1

2

24v

4 -

4.1

6760

1510

/ (/

/

/

/

enter

50ms

4.2



32

0-31

Enter

1

0

0

4

:

/

4.3.4



2

2

2

1:1

2:2

1 1

2 2

1 1

2 2

5



X2\X3

6

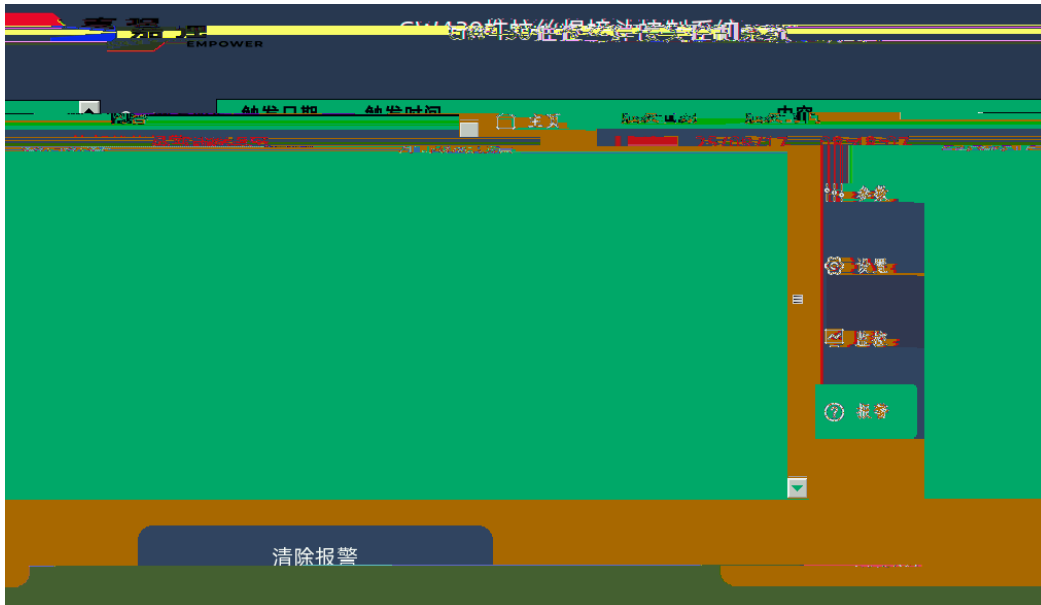

5



5. ccd

5.3

5.1

5.3.1

1.

" " _ " " , ;

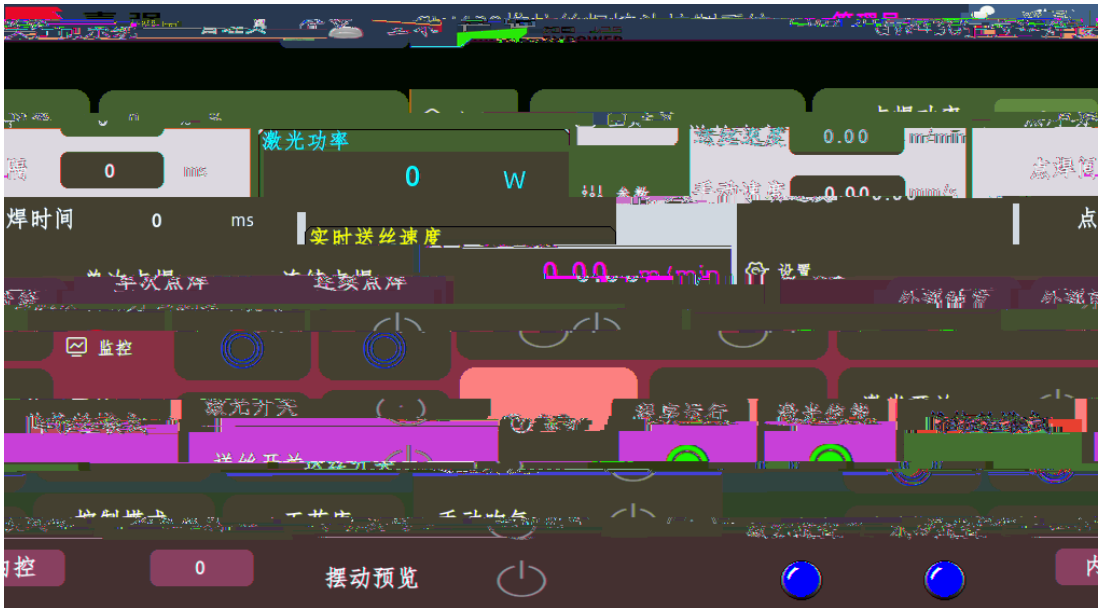

2. " _ "

6.1

1

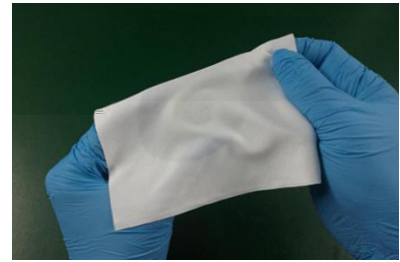
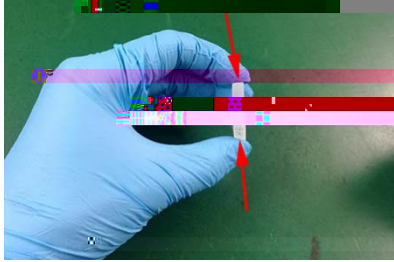

2

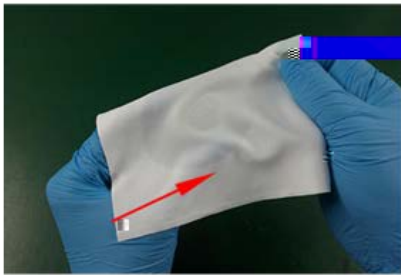

2 3

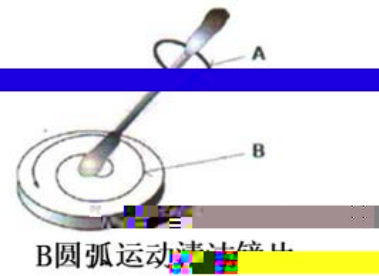

A 棉签转动方向

B 圆弧运动

3

4

3-5

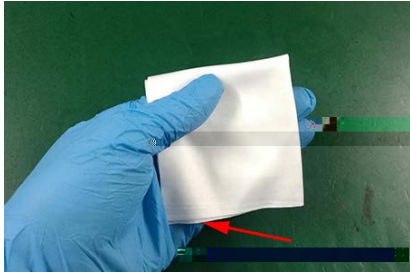

5

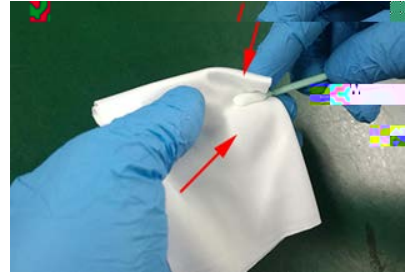

2

6.2

3-1

1)

2)

3)

4)

5)

6)

7)



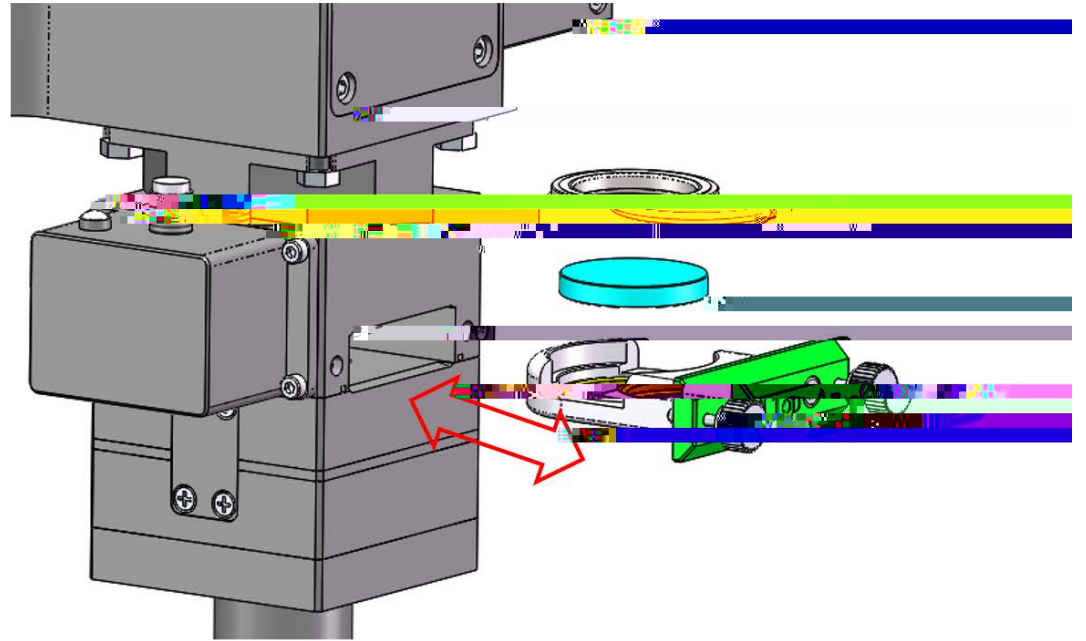

3-1